

optional
optionnel

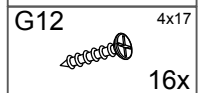

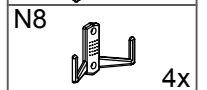
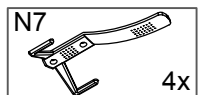
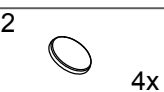
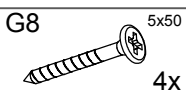
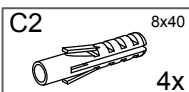
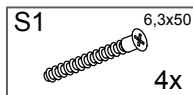
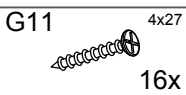
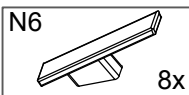
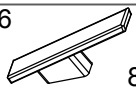
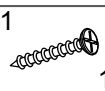
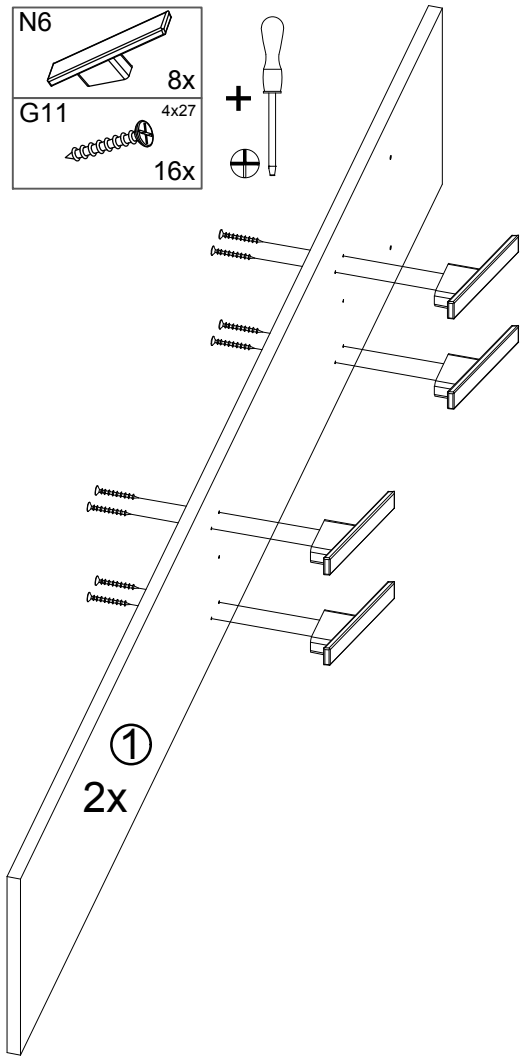
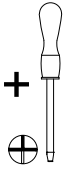

1

N6		8x
G11		4x27 16x

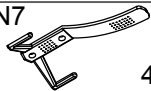

optional
optionnel

N7		4x
N8		4x
G12		4x17 16x

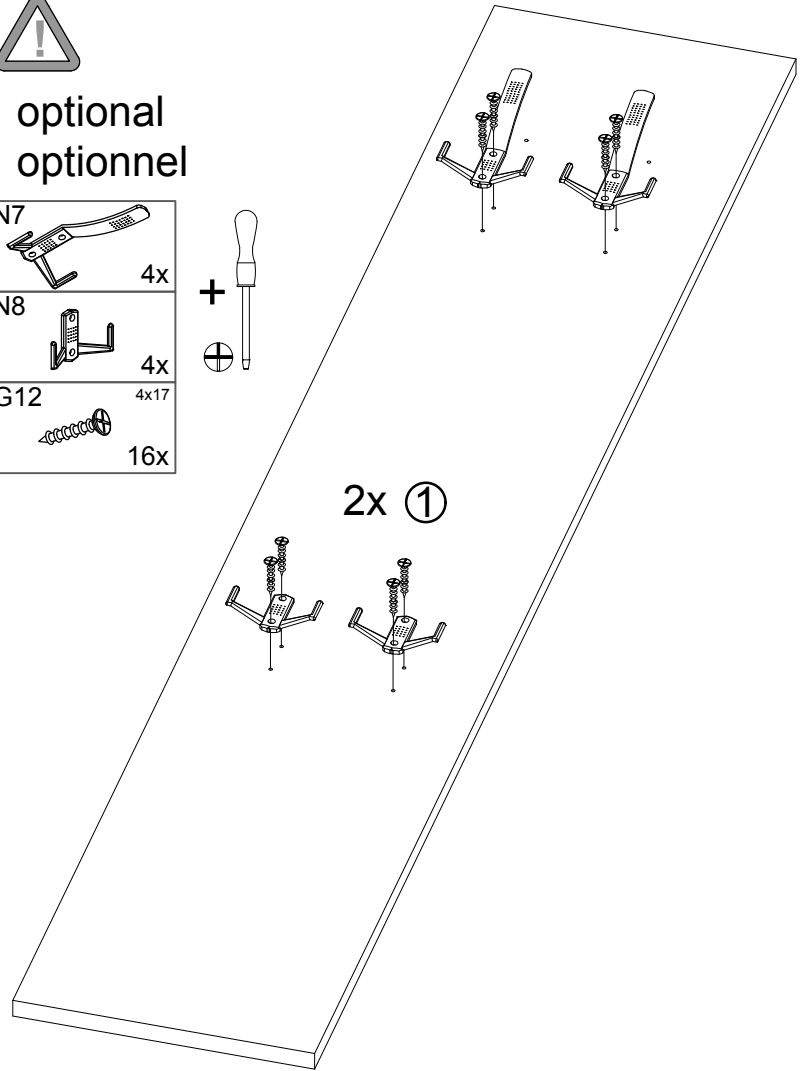
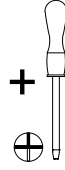

2

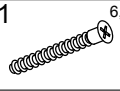
S1		6,3x50 4x
----	---	--------------

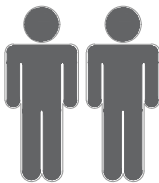
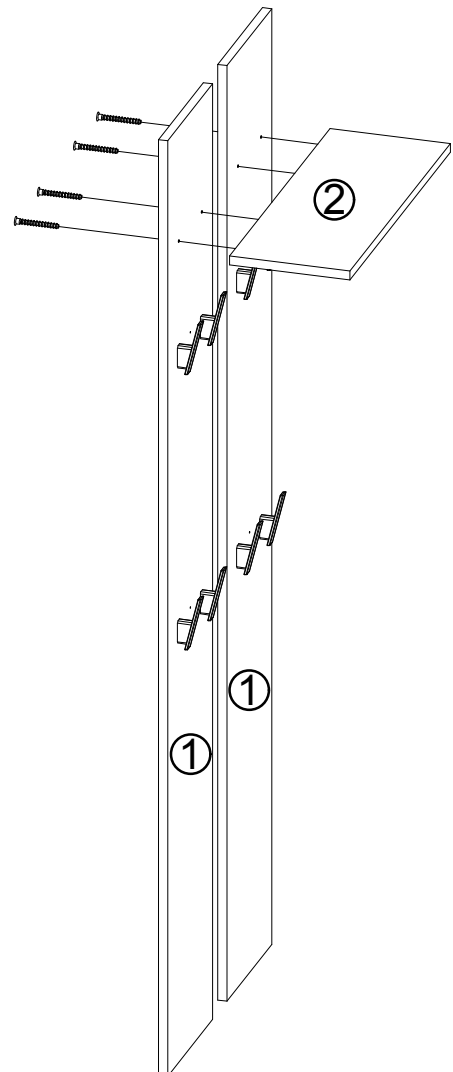
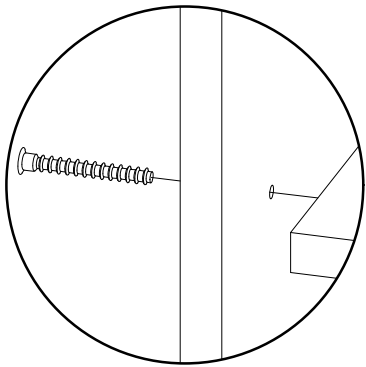
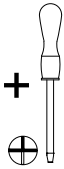

3



C2	8x40
	4x
G8	5x50
	4x

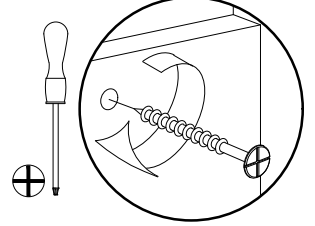
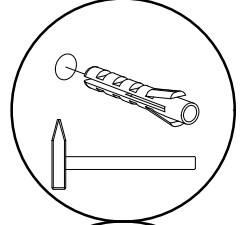
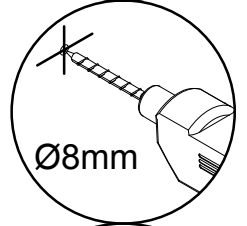
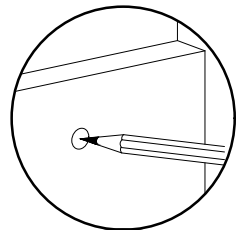

S2	4x
----	----

