



PAVOS  
Schritt:

1 + 2  
4 + 5  
7 + 8



PAVOS V2

Schritt:

1 - 3

6

7 + 8

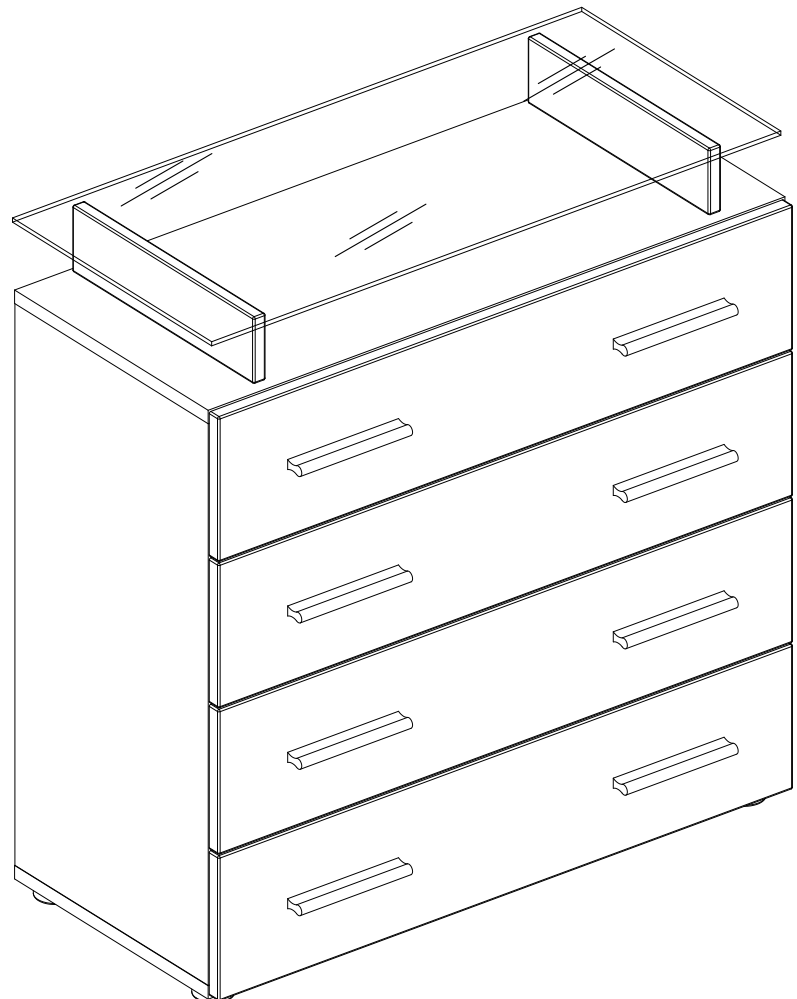

# Pavos V2

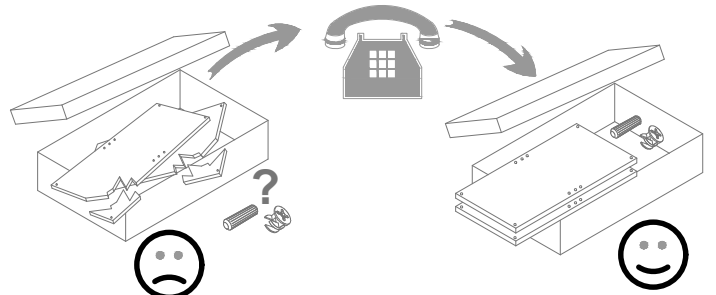
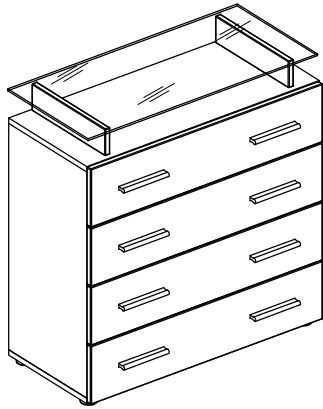
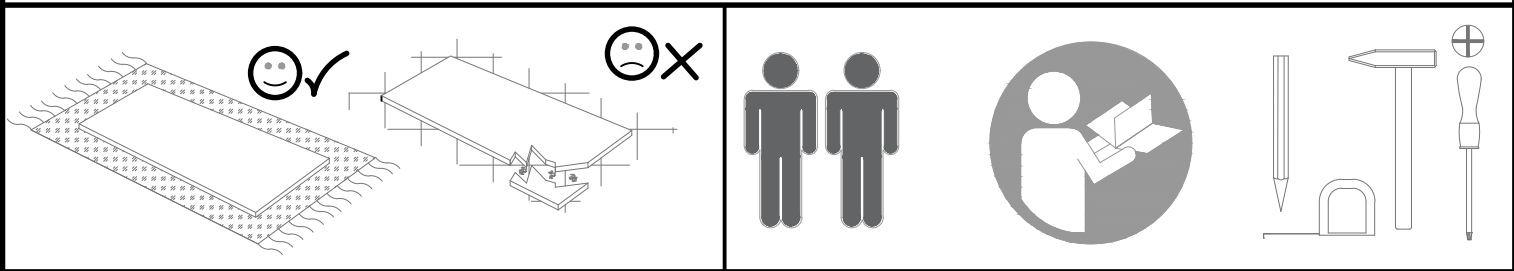

4x

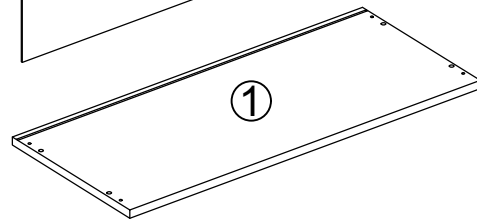
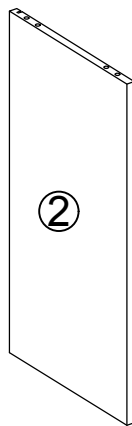
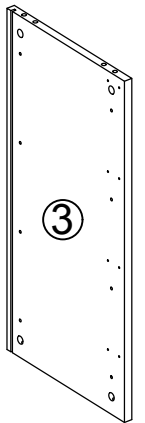
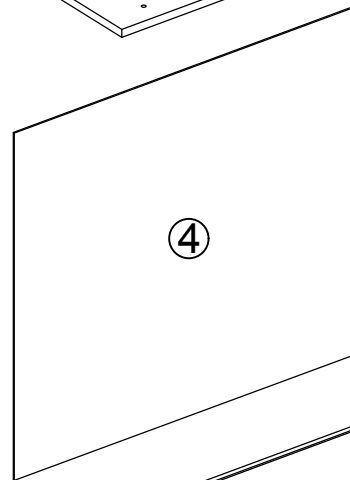
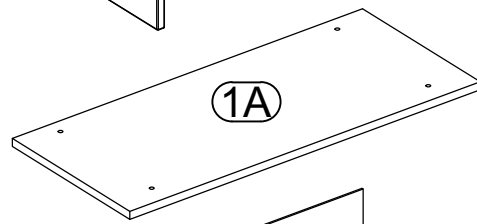
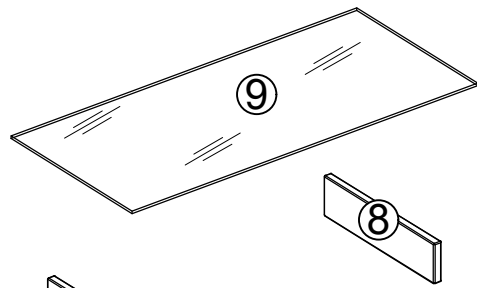
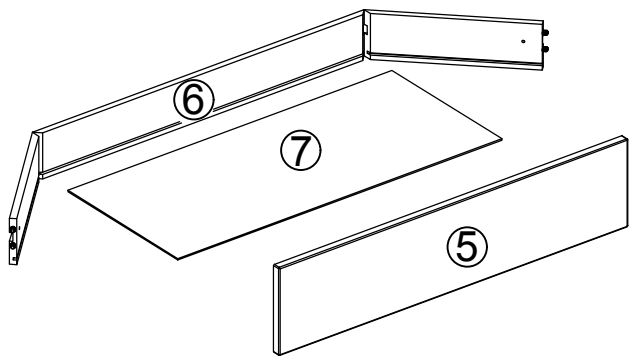

 optional  
optionnel

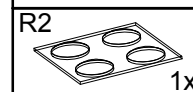
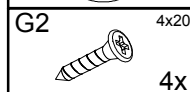
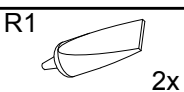
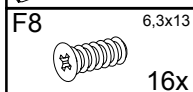
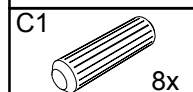
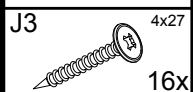
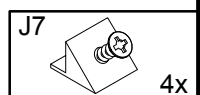
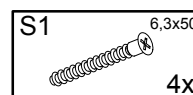
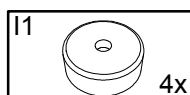
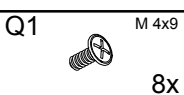
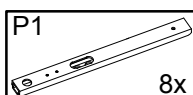
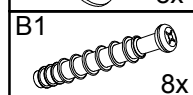
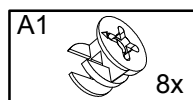
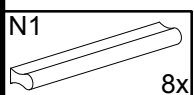
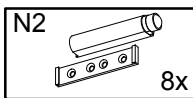
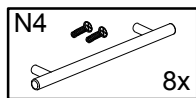

# Pavos

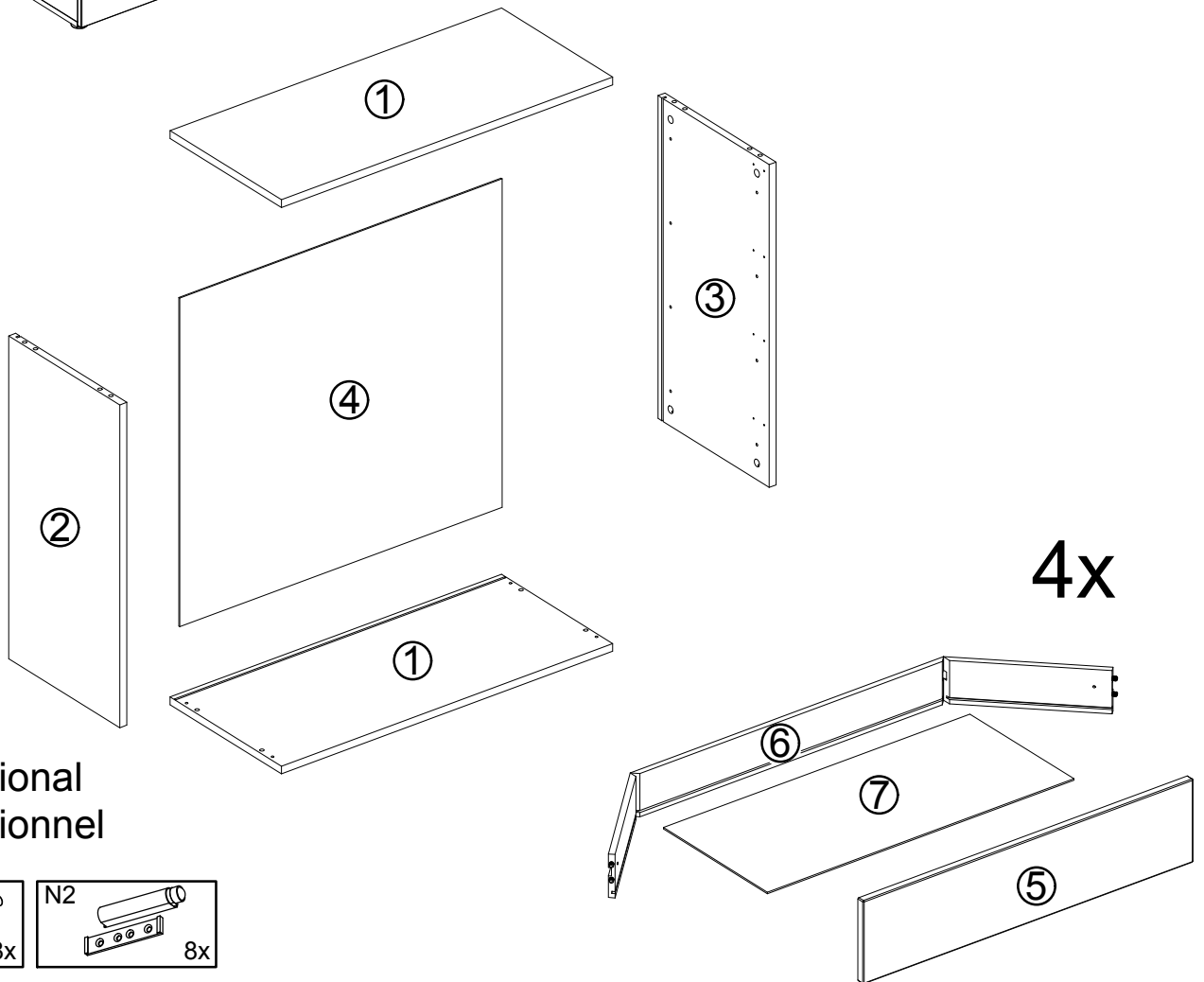
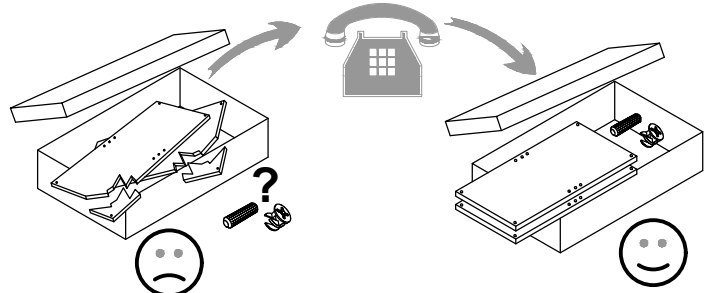
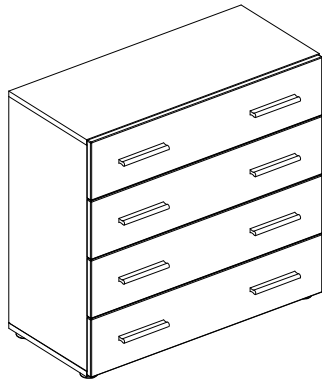
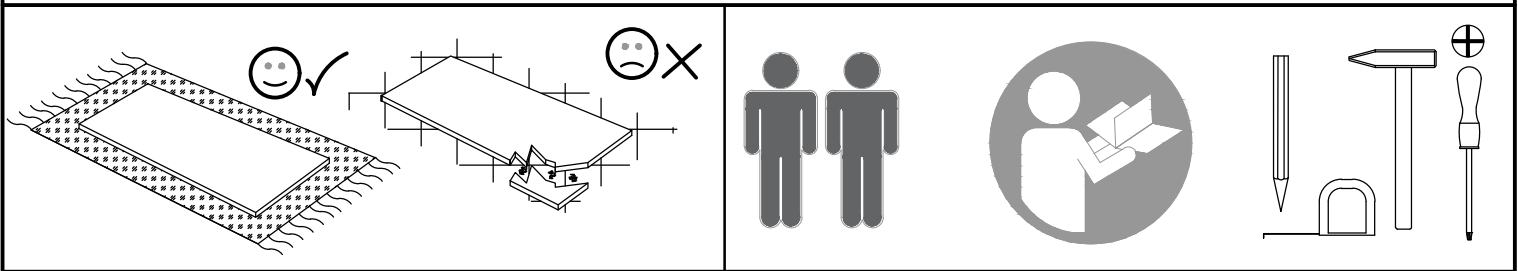

 optional  
optionnel

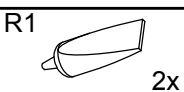
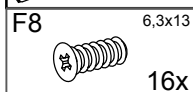
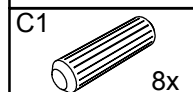
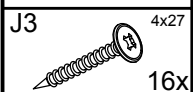
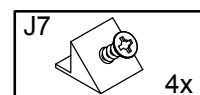
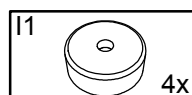
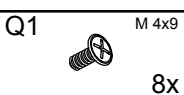
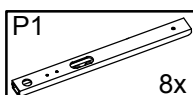
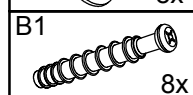
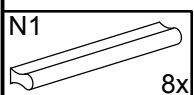
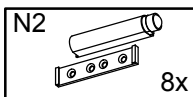
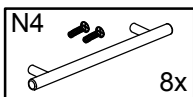

# Pavos V2 / Pavos

3/6

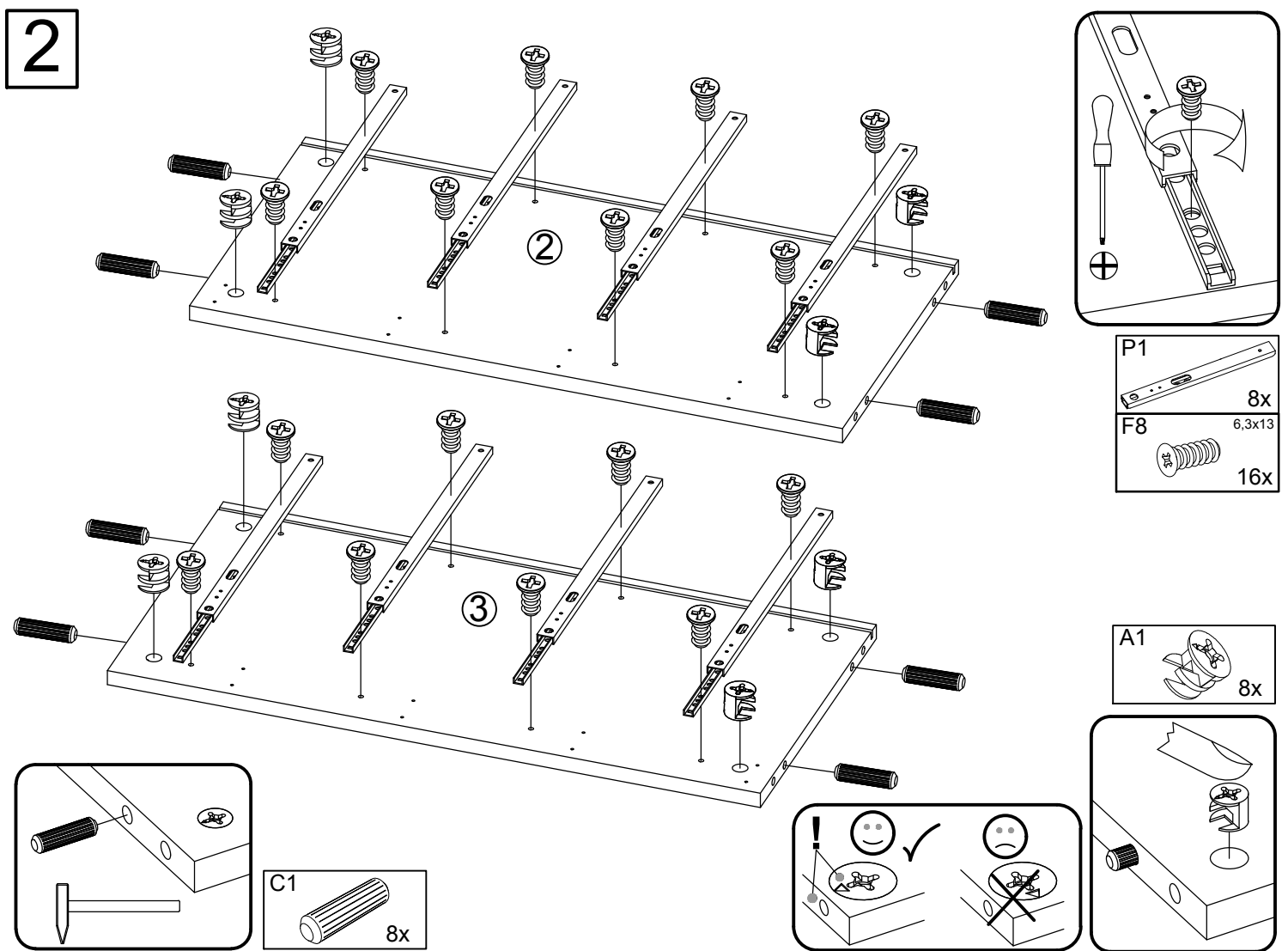
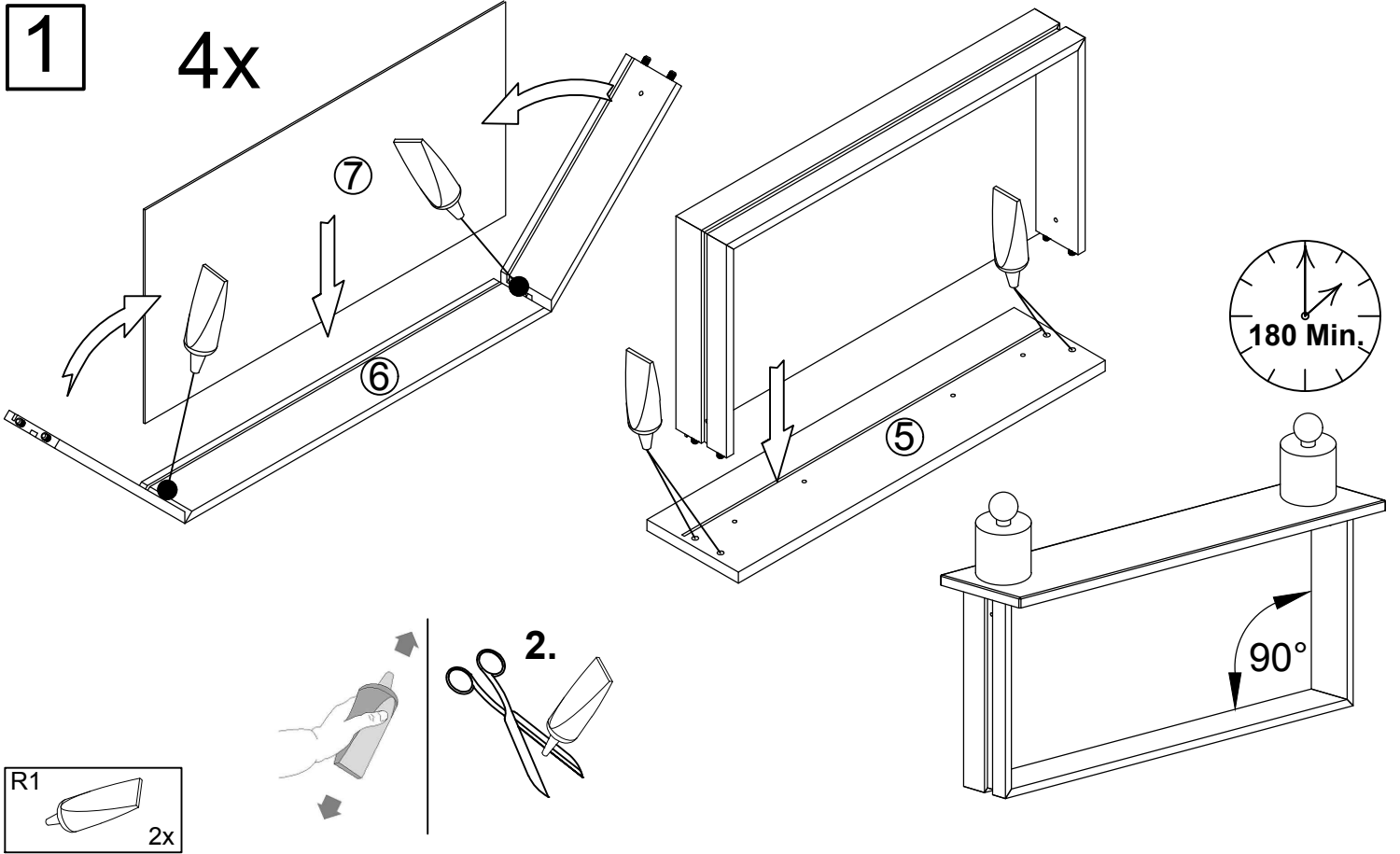

# Pavos

4/6

3

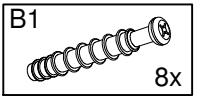
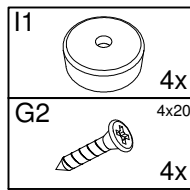
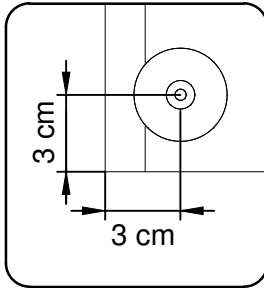
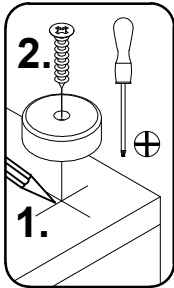
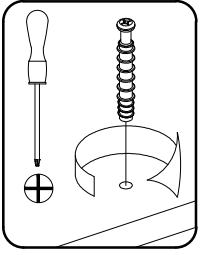
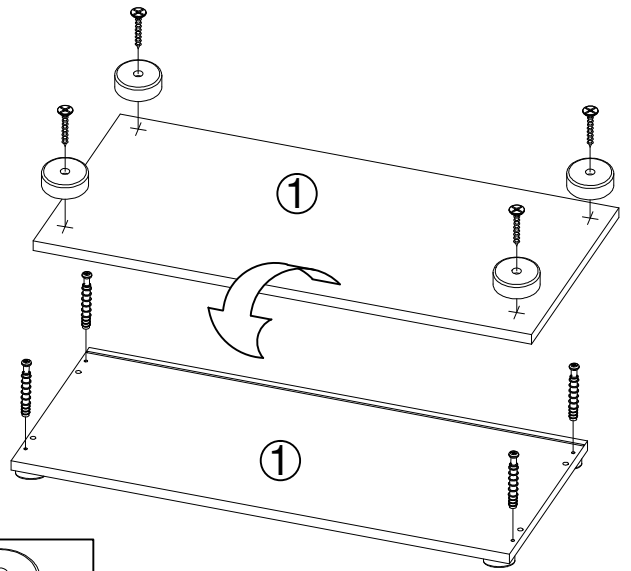
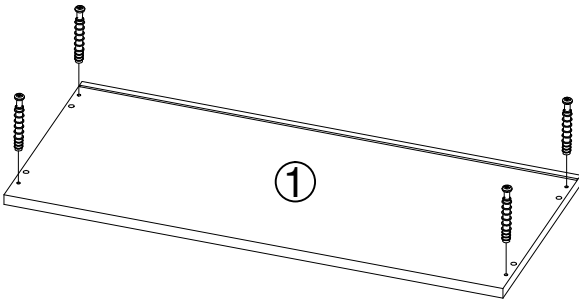

# Pavos V2

4

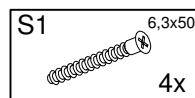
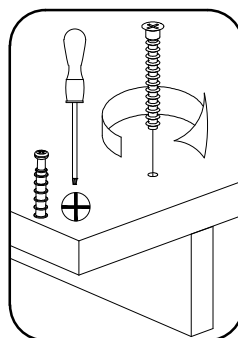
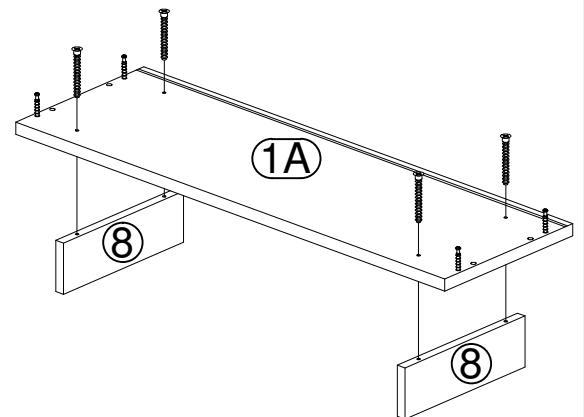
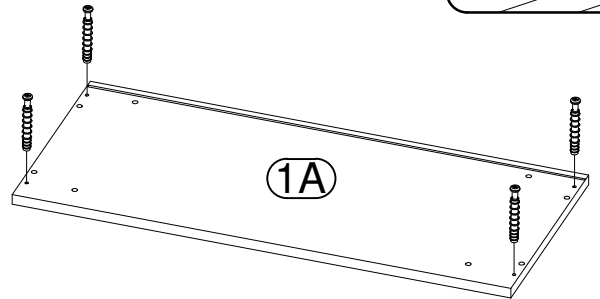
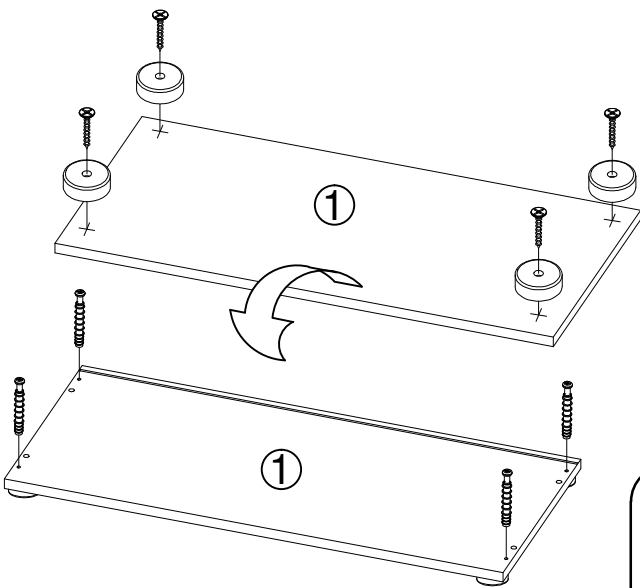
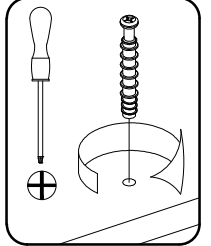
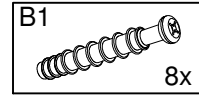
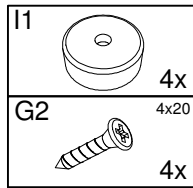
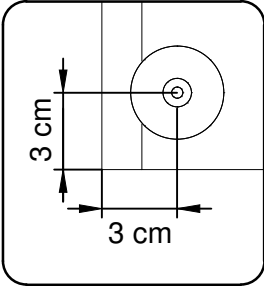
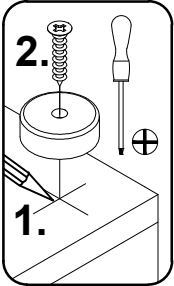

5

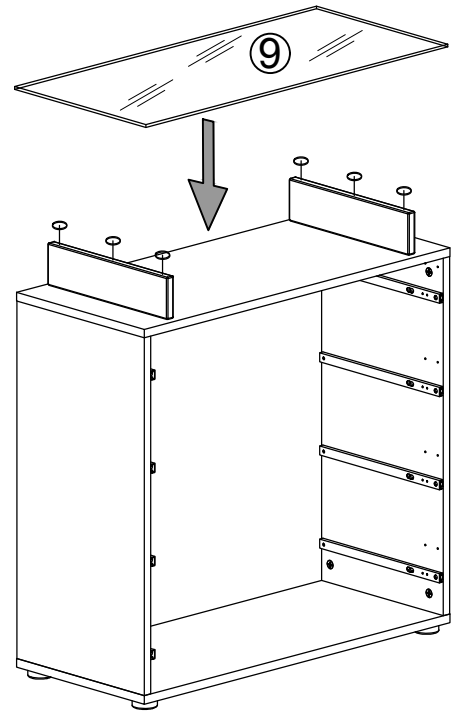
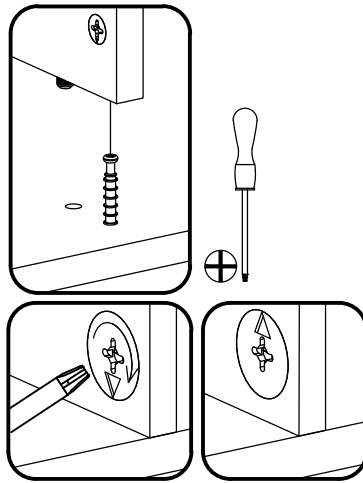
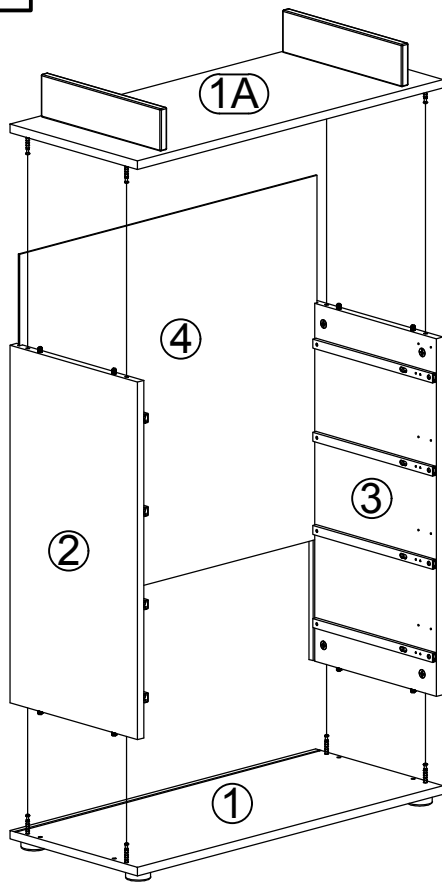
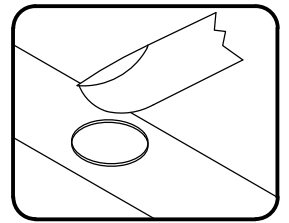
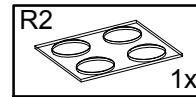

## Pavos

## Pavos/Pavos V2

6

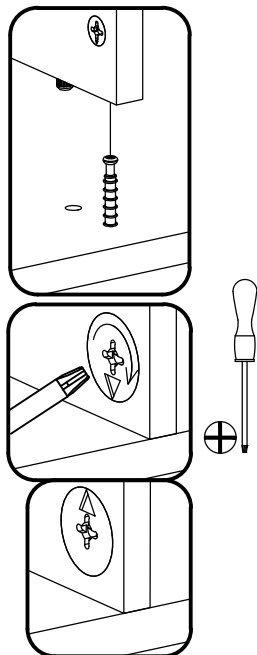
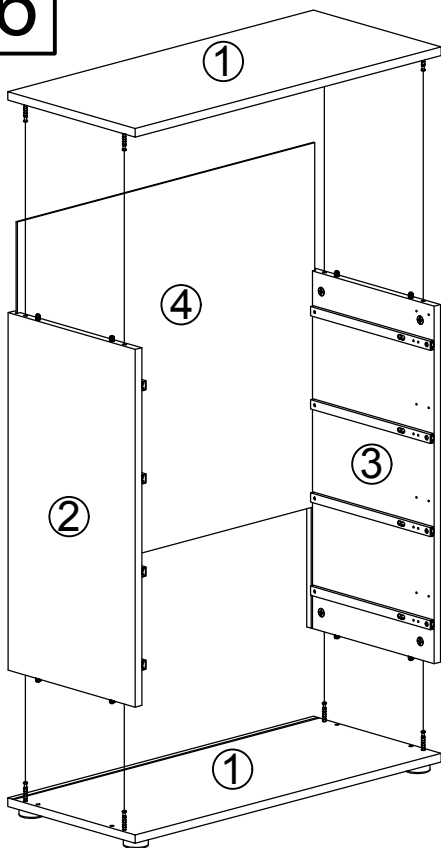

7

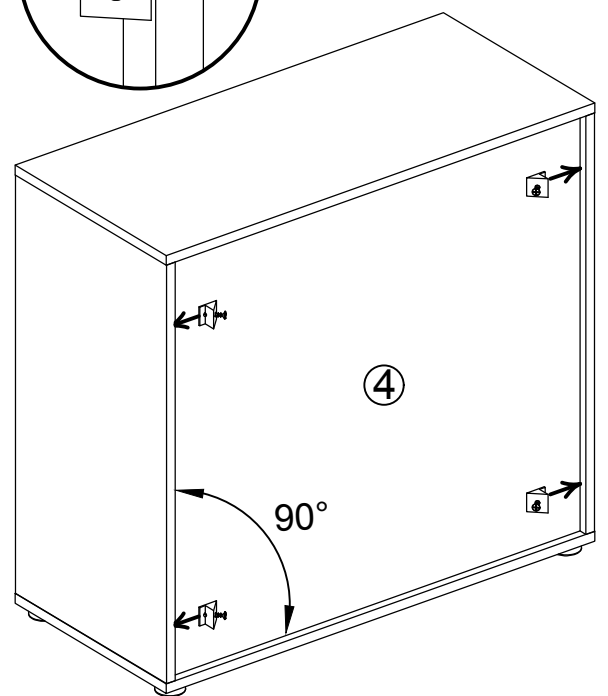
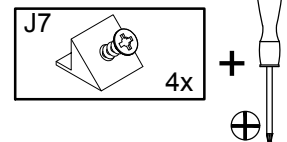
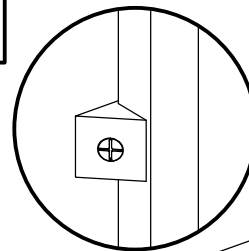

8

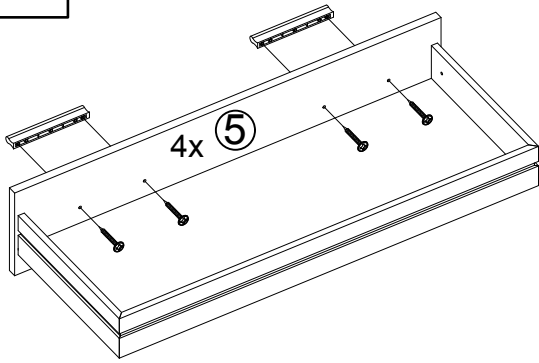

optional  
optionnel

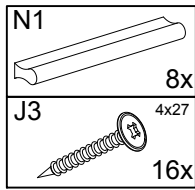
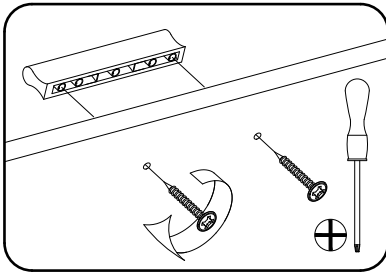
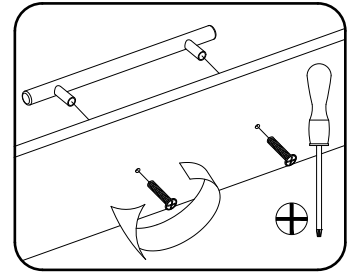
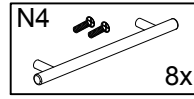

optional  
optionnel

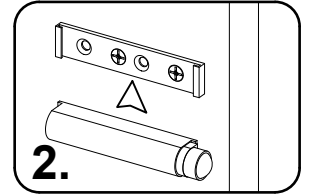
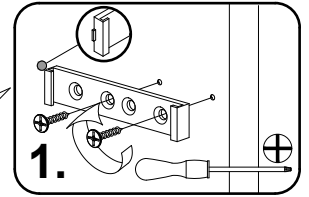
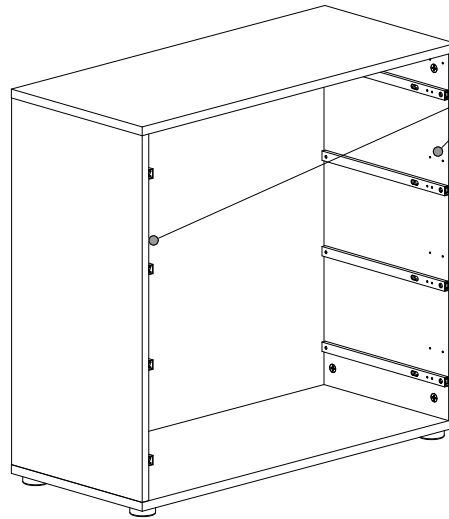
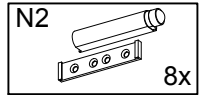

9

